

# UBW32 MX460

By: Brian Schmalz

# WWW.SCHMALZHAUS.COM/UBW32

Change Log:  
 New for v2.6 01/23/2010 v26 B  
 v2.6 White silk screen  
 v2.6 Silk screen corrections (PortE)  
 v2.6 Removed pull-up resistor pads  
 v2.6 Changed to crystal from RC oscillator  
 v2.6 Added 32KHz crystal pads  
 v2.6 Clarified port labels in schematic  
 v2.6 Updated library to use latest SparkFun  
 v2.6 D1 now 1A CDBM140-G diode

licensed under Creative Commons v3.0 Attribution licence

If you like the UBW32, please consider that SchmalzHaus can design a customized version for your specific needs. Contact brian@schmalzhaus.com for more information.

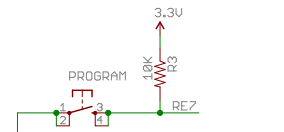
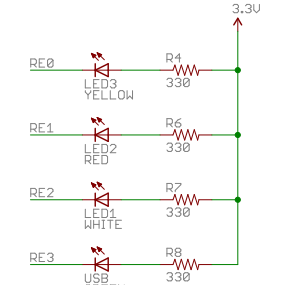
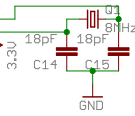
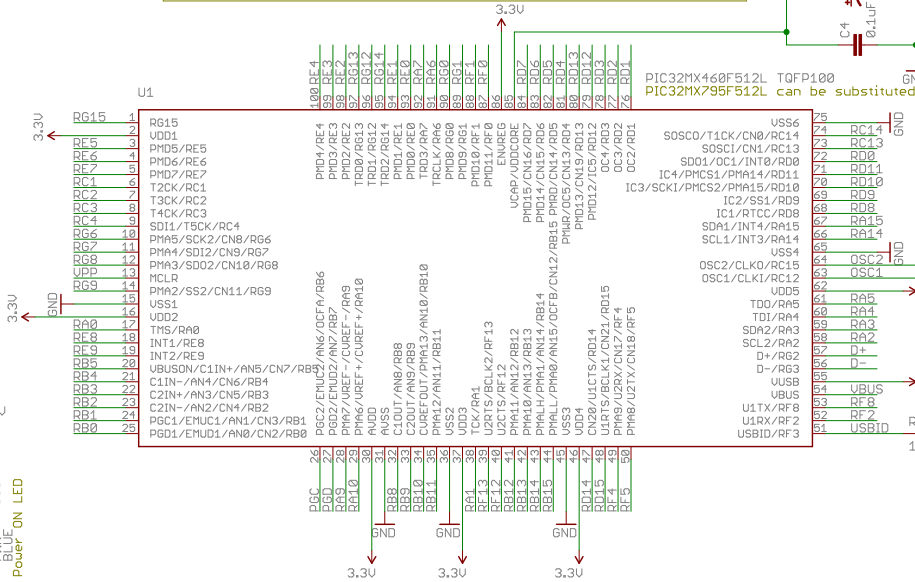
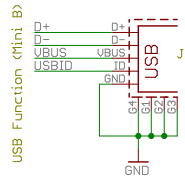
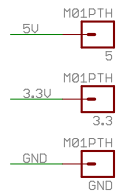
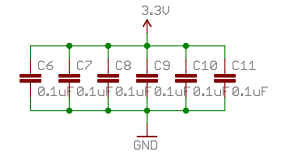
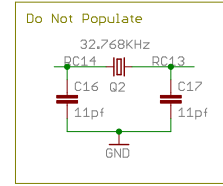
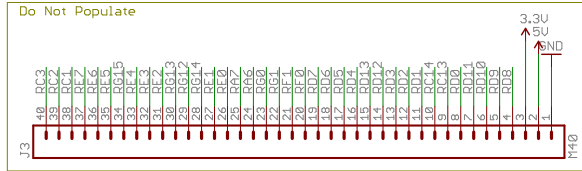
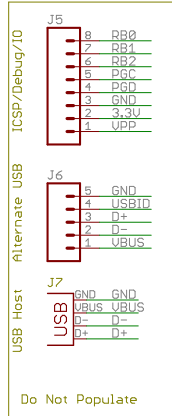

J1/J2 need 7.6 to 15V

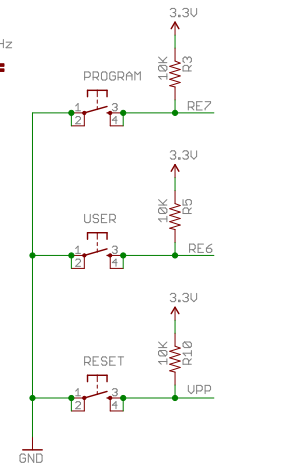
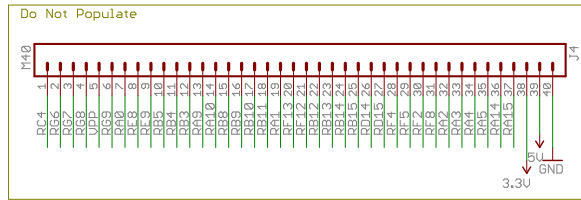
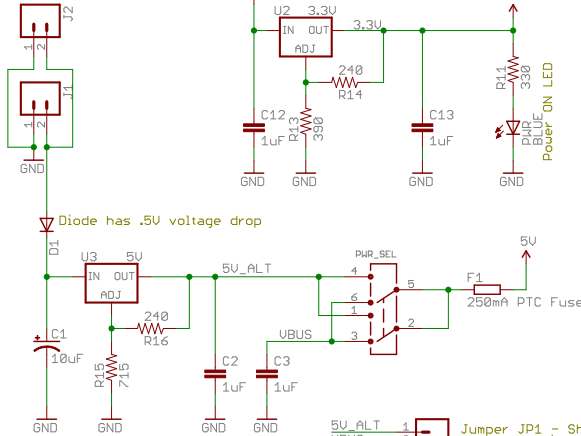

Jumper JP1 - Short to apply 5V to VBUS if you want to use USB host functionality

Title	UBW32_MX795_v262
Version:	
	7/12/2010 10:06:56 AM
Drawn By:	1/1