

Rev	Date	Description	Drawn
V1.0	2013-02-19	First release	
V2.0	2013-06-05	Modify Layout	

Title		
A10_Bridge_Board		
Size	Document Number	Rev
A4	COVER	2.0
Date:	Thursday, June 06, 2013	Sheet 1 of 3

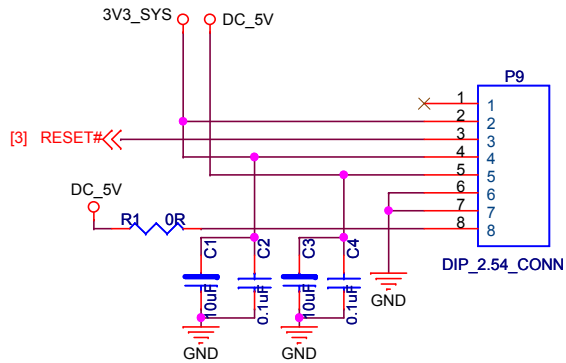

ADC

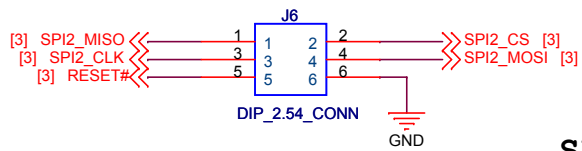

SPI2

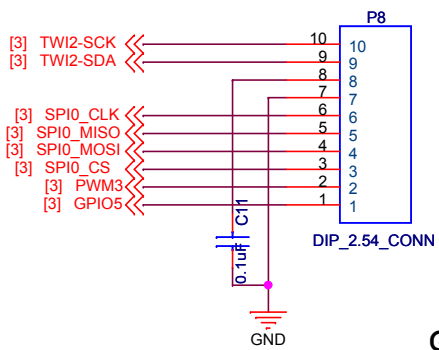
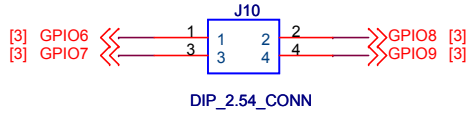

GPIO

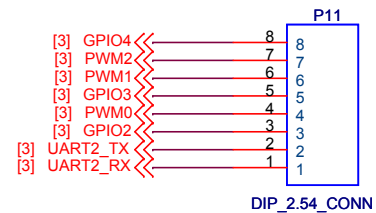

GPIO

Title		
A10_Bridge_Board		
Size	Document Number	Rev
Custom	CONN	2.0
Date:	Thursday, June 06, 2013	Sheet 2 of 3

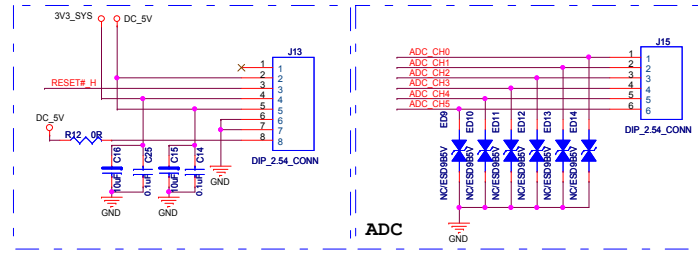
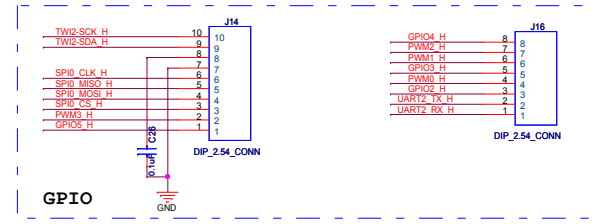
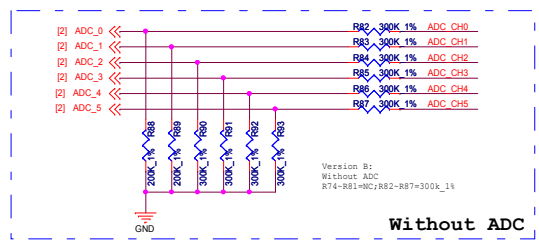
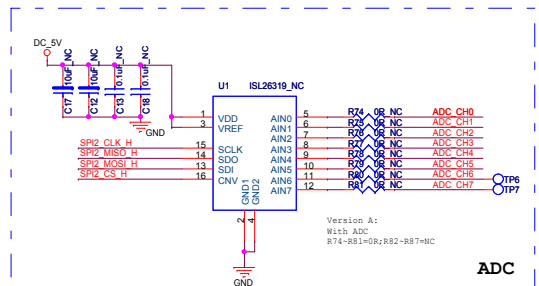
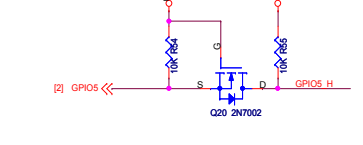
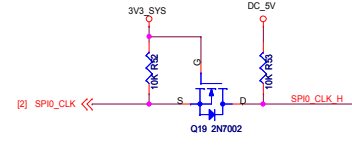
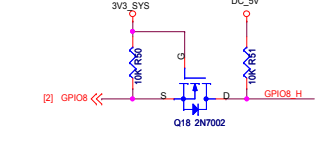
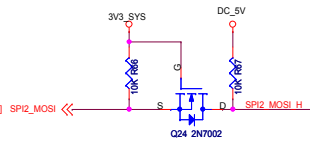
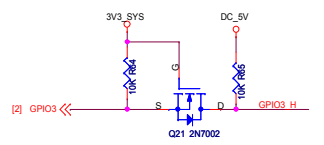
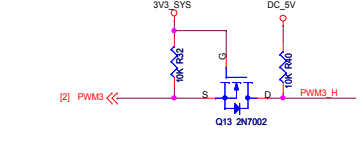
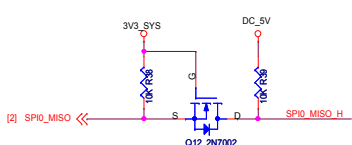
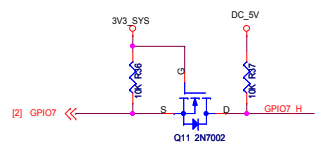
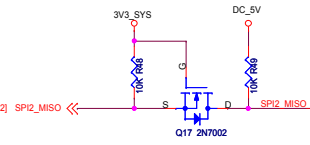
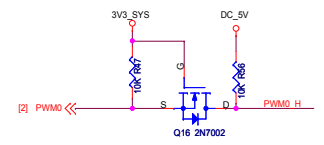
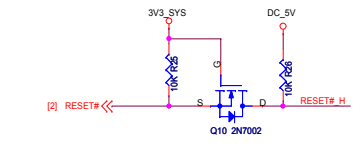
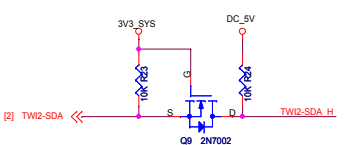
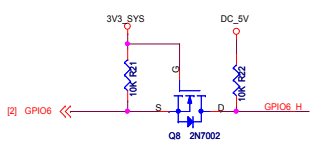
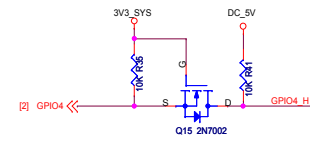
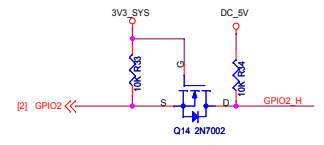
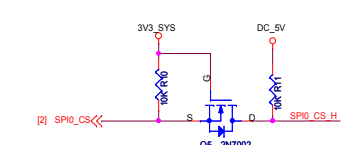
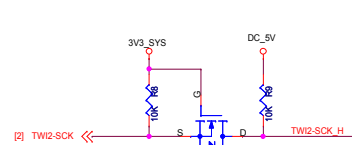
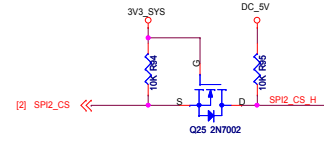
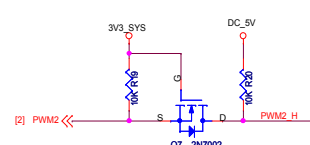
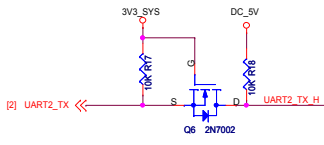
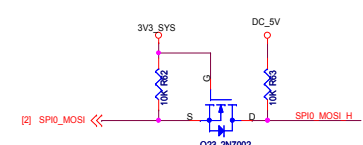
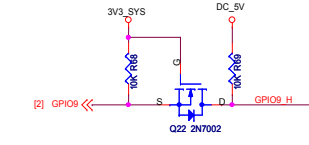
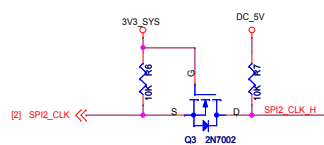
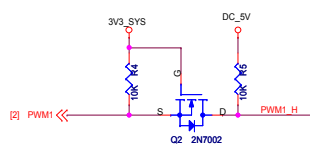
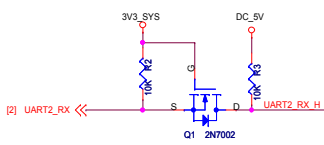

Title		
A10_Bridge_Board		
Size	Document Number	Rev
C	Level_Shift	2.0
Date:	Thursday, June 06, 2013	Sheet 3 of 3